

Features

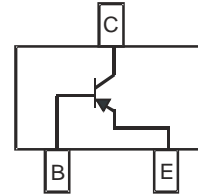
- Epitaxial Planar Die Construction
- Complementary NPN Type Available (DNLS160)
- Surface Mount Package Suited for Automated Assembly
- **Lead Free/RoHS Compliant (Note 1)**
- **"Green Device" (Note 2)**
- **Qualified to AEC-Q101 Standards for High Reliability**



SOT-23

Mechanical Data

- Case: SOT-23
- Case Material: Molded Plastic, "Green" Molding Compound. UL Flammability Classification Rating 94V-0
- Moisture Sensitivity: Level 1 per J-STD-020D
- Terminals: Finish — Matte Tin annealed over Copper leadframe. Solderable per MIL-STD-202, Method 208
- Marking Information: See Page 4
- Ordering Information: See Page 4
- Weight: 0.008 grams (approximate)



Schematic and Pin Configuration

Maximum Ratings @ $T_A = 25^\circ\text{C}$ unless otherwise specified

Characteristic	Symbol	Value	Unit
Collector-Base Voltage	V_{CBO}	-80	V
Collector-Emitter Voltage	V_{CEO}	-60	V
Emitter-Base Voltage	V_{EBO}	-5	V
Collector Current - Continuous	I_C	-1	A
Peak Pulse Collector Current	I_{CM}	-2	A
Base Current (DC)	I_B	-300	mA

Thermal Characteristics

Characteristic	Symbol	Value	Unit
Power Dissipation (Note 3) @ $T_A = 25^\circ\text{C}$	P_D	300	mW
Thermal Resistance, Junction to Ambient (Note 3) @ $T_A = 25^\circ\text{C}$	$R_{\theta JA}$	417	$^\circ\text{C}/\text{W}$
Operating and Storage Temperature Range	T_J, T_{STG}	-55 to +150	$^\circ\text{C}$

- Notes:
1. No purposefully added lead.
 2. Diode's Inc.'s "Green" policy can be found on our website at http://www.diodes.com/products/lead_free/index.php.
 3. Device mounted on FR-4 PCB, 1 inch x 0.85 inch x 0.062 inch; pad layout as shown on page 4 or in Diodes Inc. suggested pad layout document AP02001, which can be found on our website at <http://www.diodes.com/datasheets/ap02001.pdf>.

Electrical Characteristics @ $T_A = 25^\circ\text{C}$ unless otherwise specified

Characteristic	Symbol	Min	Typ	Max	Unit	Test Condition
OFF CHARACTERISTICS (Note 4)						
Collector-Base Breakdown Voltage	$V_{(BR)CBO}$	-80	—	—	V	$I_C = -100\mu\text{A}, I_E = 0$
Collector-Emitter Breakdown Voltage	$V_{(BR)CEO}$	-60	—	—	V	$I_C = -10\text{mA}, I_B = 0$
Emitter-Base Breakdown Voltage	$V_{(BR)EBO}$	-5	—	—	V	$I_E = -100\mu\text{A}, I_C = 0$
Collector Cutoff Current	I_{CBO}	—	—	-100 -50	nA μA	$V_{CB} = -60\text{V}, I_E = 0$ $V_{CB} = -60\text{V}, I_E = 0, T_A = 150^\circ\text{C}$
Collector Cutoff Current	I_{CES}	—	—	-100	nA	$V_{CE} = -60\text{V}, V_{BE} = 0$
Emitter Cutoff Current	I_{EBO}	—	—	-100	nA	$V_{EB} = -5\text{V}, I_C = 0$
ON CHARACTERISTICS (Note 4)						
DC Current Gain	h_{FE}	200 150 100	325 250 180	— — —	V	$V_{CE} = -5\text{V}, I_C = -1\text{mA}$ $V_{CE} = -5\text{V}, I_C = -500\text{mA}$ $V_{CE} = -5\text{V}, I_C = -1\text{A}$
Collector-Emitter Saturation Voltage	$V_{CE(SAT)}$	— — —	-90 -90 -160	-160 -175 -330	mV	$I_C = -100\text{mA}, I_B = -1\text{mA}$ $I_C = -500\text{mA}, I_B = -50\text{mA}$ $I_C = -1\text{A}, I_B = -100\text{mA}$
Collector-Emitter Saturation Resistance	$R_{CE(SAT)}$	—	160	330	$\text{m}\Omega$	$I_C = -1\text{A}, I_B = -100\text{mA}$
Base-Emitter Saturation Voltage	$V_{BE(SAT)}$	—	-0.95	-1.1	V	$I_C = -1\text{A}, I_B = -50\text{mA}$
Base-Emitter Turn On Voltage	$V_{BE(ON)}$	—	-0.82	-0.9	V	$V_{CE} = -5\text{V}, I_C = -1\text{A}$
SMALL SIGNAL CHARACTERISTICS						
Output Capacitance	C_{obo}	—	10	15	pF	$V_{CB} = -10\text{V}, f = 1.0\text{MHz}$
Current Gain-Bandwidth Product	f_T	150	220	—	MHz	$V_{CE} = -10\text{V}, I_C = -50\text{mA}, f = 100\text{MHz}$

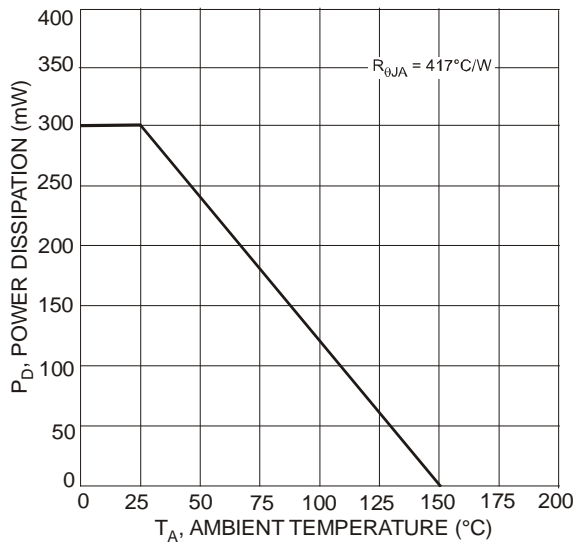
 Notes: 4. Measured under pulsed conditions. Pulse width = 300 μs . Duty cycle $\leq 2\%$.


Fig. 1 Maximum Power Dissipation vs. Ambient Temperature

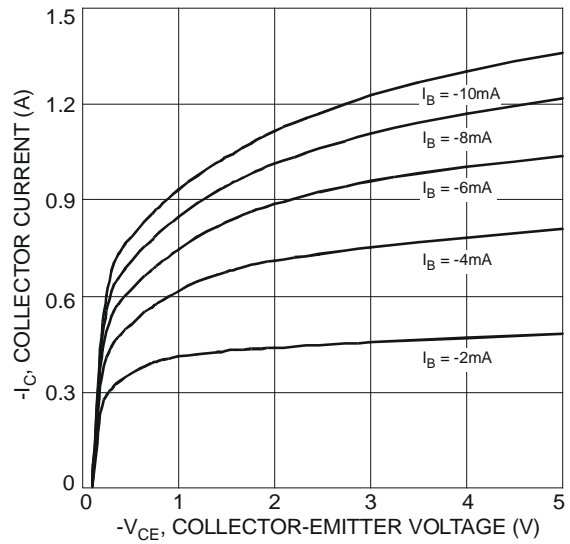


Fig. 2 Typical Collector Current vs. Collector-Emitter Voltage

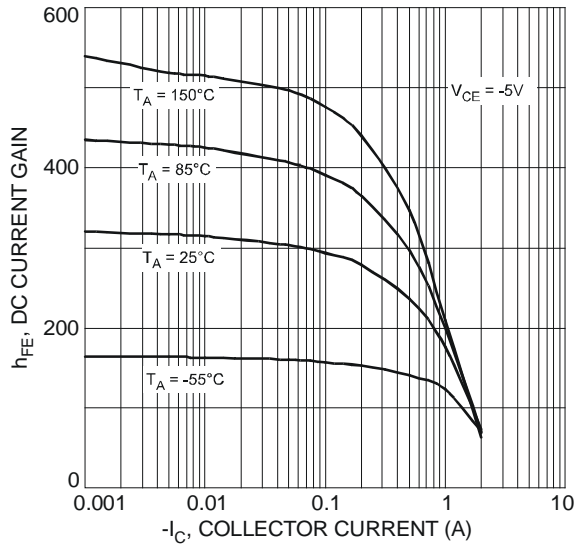


Fig. 3 Typical DC Current Gain vs. Collector Current

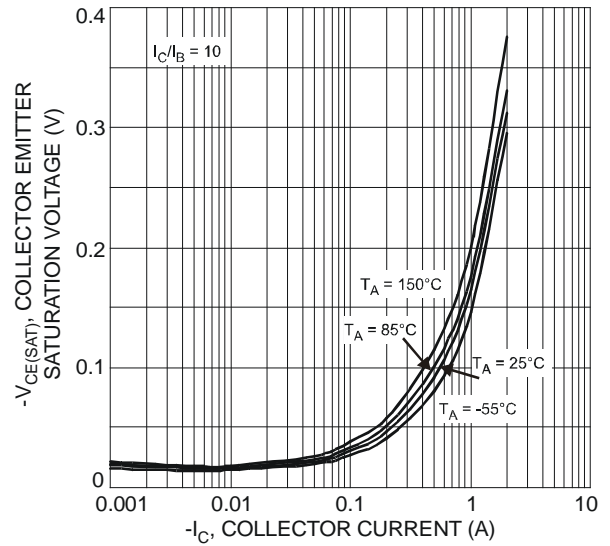


Fig. 4 Typical Collector Emitter Saturation Voltage vs. Collector Current

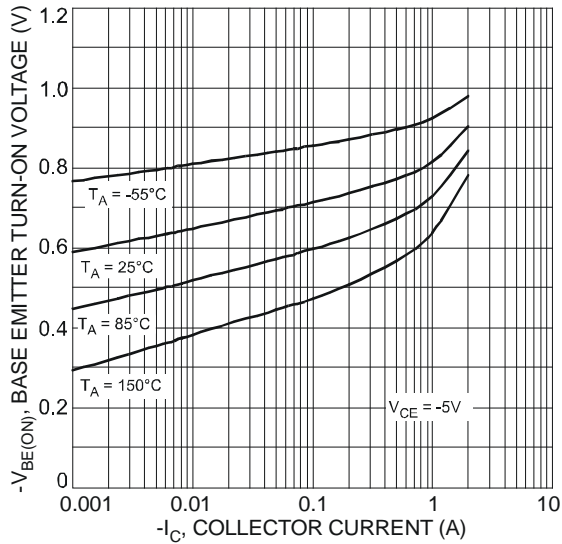


Fig. 5 Typical Base Emitter Turn-On Voltage vs. Collector Current

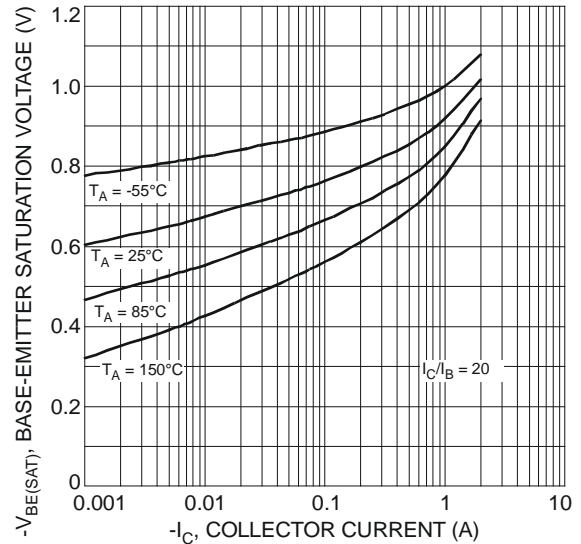


Fig. 6 Typical Base-Emitter Saturation Voltage vs. Collector Current

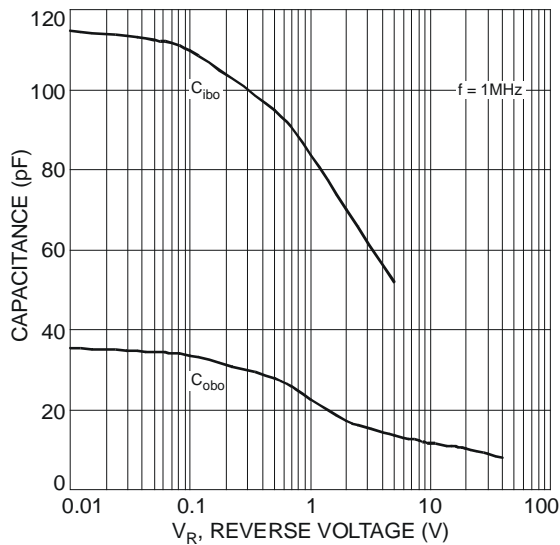


Fig. 7 Typical Total Capacitance

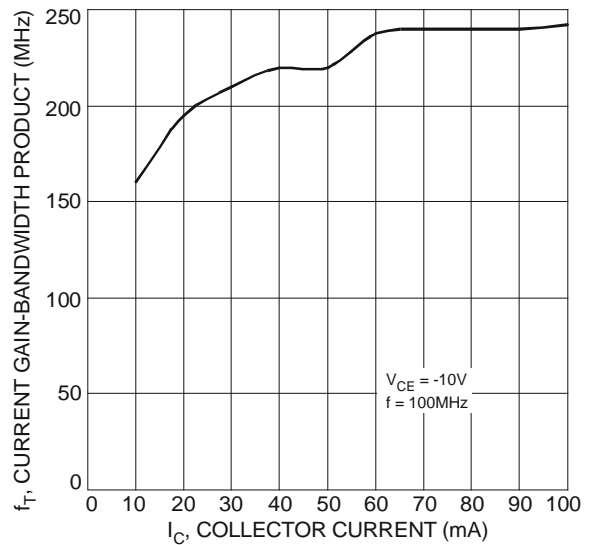


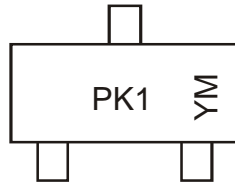
Fig. 8 Typical Gain-Bandwidth Product vs. Collector Current

Ordering Information (Note 5)

Device	Packaging	Shipping
DPLS160-7	SOT-23	3000/Tape & Reel

Notes: 5. For packaging details, go to our website at <http://www.diodes.com/datasheets/ap02007.pdf>.

Marking Information



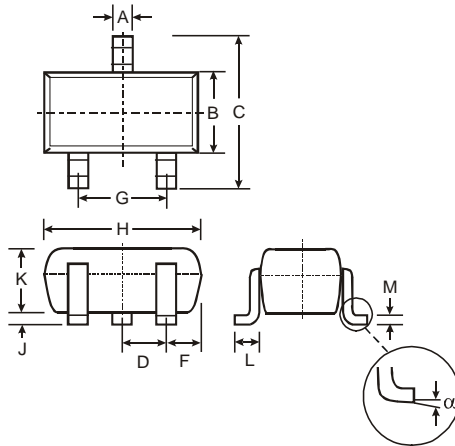
PK1 = Product Type Marking Code
 YM = Date Code Marking
 Y = Year ex: U = 2007
 M = Month ex: 9 = September

Date Code Key

Year	2008	2009	2010	2011	2012	2013	2014	2015
Code	V	W	X	Y	Z	A	B	C

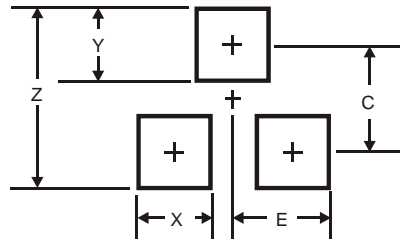
Month	Jan	Feb	Mar	Apr	May	Jun	Jul	Aug	Sep	Oct	Nov	Dec
Code	1	2	3	4	5	6	7	8	9	O	N	D

Package Outline Dimensions



SOT-23		
Dim	Min	Max
A	0.37	0.51
B	1.20	1.40
C	2.30	2.50
D	0.89	1.03
F	0.45	0.60
G	1.78	2.05
H	2.80	3.00
J	0.013	0.10
K	0.903	1.10
L	0.45	0.61
M	0.085	0.180
α	0°	8°
All Dimensions in mm		

Suggested Pad Layout



Dimensions	Value (in mm)
Z	2.9
X	0.8
Y	0.9
C	2.0
E	1.35

IMPORTANT NOTICE

Diodes Incorporated and its subsidiaries reserve the right to make modifications, enhancements, improvements, corrections or other changes without further notice to any product herein. Diodes Incorporated does not assume any liability arising out of the application or use of any product described herein; neither does it convey any license under its patent rights, nor the rights of others. The user of products in such applications shall assume all risks of such use and will agree to hold Diodes Incorporated and all the companies whose products are represented on our website, harmless against all damages.

LIFE SUPPORT

Diodes Incorporated products are not authorized for use as critical components in life support devices or systems without the expressed written approval of the President of Diodes Incorporated.